

18zT



Concrete solutions. Always.

Engine 3TNV70

Engine power 11,2 kW - 15,2 HP

Operating Weight 1.730 - 1.810 kg

 **EUROCOMACH**[®]

18ZT

Operating weight with canopy (with rubber tracks)	kg	1.730
Operating weight with cabin (rubber tracks)	kg	1.810
Travelling speed	km/h	1 ^a : 0 ÷ 2,2 / 2 ^a : 0 ÷ 4,2
Slew speed	rpm	12

ENGINE

Type	YANMAR 3TNV70 - STAGE 5	
Power (2.100 rpm)	kW - HP	11,2 - 15,2
Displacement	cc	854
Number of cylinders	n°	3
Cooling	water	
Consumption	lt/h	2,4
Alternator	V (A)	12 (35)
Battery	V (Ah)	12 (65)

HYDRAULIC SYSTEM

Pump type	variable flow	
Pump displacement	cc	8+8+6,5
Pump capacity	lt/min	17,6+17,6+14,3
Max. circuit calibration pressure	bar	210
Auxiliary system:	Max capacity	lt/min
	Max pressure	bar
		36
		210

PERFORMANCES

Max digging depth standard arm (optional arm)	mm	2.300 (2.500)
Max dumping height with canopy standard arm (optional arm)	mm	3.020 (3.140)
Max dumping height with cab standard arm (optional arm)	mm	2.860 (2.960)
Bucket breaking force (standard arm) ISO 6015	daN	1.550
Arm breaking force (standard arm) ISO 6015	daN	1.050
Traction force	daN	1.500
Ground bearing pressure with rubber tracks and canopy (with cabin)	kg/cm ²	0,32 (0,33)
Max slope	60% - 30°	

DIMENSIONS

Maximum width	mm	990 - 1.300
Total height	mm	2.357
Rear rotation radius	mm	650
Digging arm length standard (optional)	mm	1.150 (1.350)
Tracks width	mm	230
Rollers number (for each side)	n°	3

FILLINGS

Fuel tank	lt	18
Hydraulic oil tank	lt	20
Hydraulic circuit capacity	lt	30
Cooling system capacity	lt	4
Engine oil	lt	2,8

CONTROLS

Boom, dipper stick, bucket and turret swing	2 pilot joysticks
Track movements (included counter rotation)	2 levers
Dozer blade	mechanical lever
Auxiliary circuit (simple or double effect)	left pedal
Boom swing	right pedal

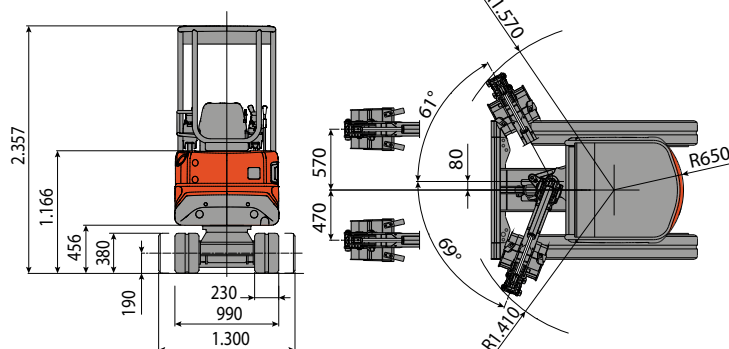
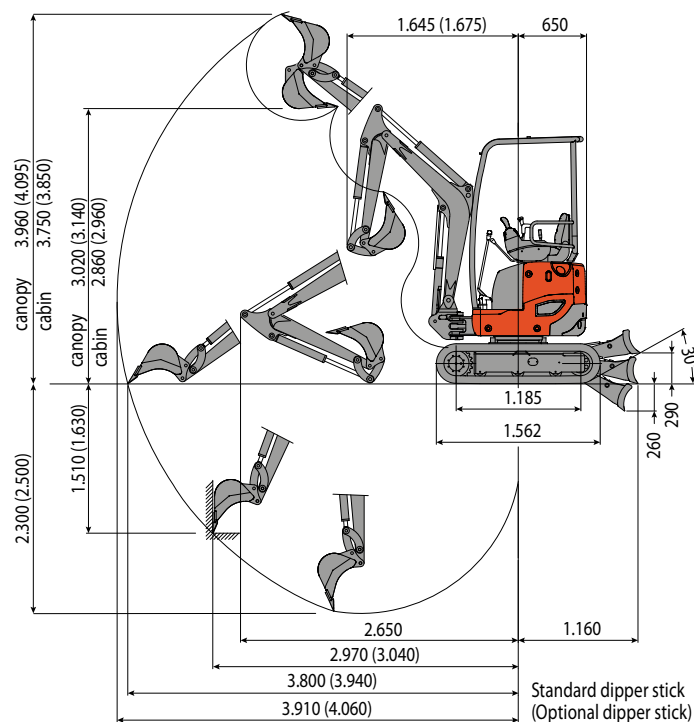

LIFTING CAPACITY

Opening arm from the rotation's center (m)
Lifting capacity (kg) at 1.0 m height

	1,5	2	2,5	3	MAX
Frontal and lowered dozer blade	660	440	360	310	250
Frontal and lifted dozer blade	610	410	280	205	180
Lateral, open undercarriage	610	410	235	195	160

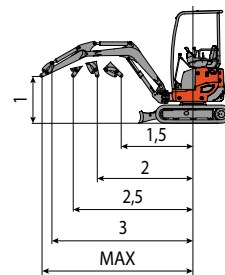

The lifting capacity is based on the ISO 10567 and it does not exceed more than the 75% of static tipping load or more than the 87% of the hydraulic lifting capacity of the machine.

 **EUROCOMACH®**